

Energizer®



CORDLESS PRUNING MACHINE

EZ20VSJIN-A

USER GUIDE

CAUTION: Read this manual before using this machine!

Energizer®

©2022 Energizer. Energizer and certain graphic designs are trademarks of Energizer Brands, LLC and related subsidiaries and are used under license by Builder SAS. All other brand names are trademarks of their respective owners. Neither Builder SAS nor Energizer Brands, LLC is affiliated with the respective owners of their trademarks.

Let's get started.

You're excited to power up, so we'll keep this brief!

CONTENTS

1. SAFETY INSTRUCTIONS	5
2. KNOW YOUR PRODUCT	11
3. ASSEMBLY	12
4. OPERATION	13
5. CLEANING AND MAINTENANCE ..	16
6. DISPOSAL	18
7. DECLARATION OF CONFORMITY	19
8. WARRANTY	20
9. PRODUCT FAILURE	21
10. WARRANTY EXCLUSIONS	22

1. SAFETY INSTRUCTIONS

1.1 GENERAL POWER TOOL SAFETY WARNINGS



WARNING! Read all safety warnings, instructions, illustrations and specifications provided with this power tool. *Failure to follow all instructions listed below may result in electric shock, fire and/or serious injury.*

Save all warnings and instructions for future reference.

The term "power tool" in the warnings refers to your mains-operated (corded) power tool or battery-operated (cordless) power tool.

1) Work area safety

- a) **Keep work area clean and well lit.** *Cluttered or dark areas invite accidents.*
- b) **Do not operate power tools in explosive atmospheres, such as in the presence of flammable liquids, gases or dust.** *Power tools create sparks which may ignite the dust or fumes.*
- c) **Keep children and bystanders away while operating a power tool.** *Distractions can cause you to lose control.*

2) Electrical safety

- a) **Power tool plugs must match the outlet. Never modify the plug in any way. Do not use any adapter plugs with earthed (grounded) power tools.** *Unmodified plugs and matching outlets will reduce risk of electric shock.*
- b) **Avoid body contact with earthed or grounded surfaces, such as pipes, radiators, ranges and refrigerators.** *There is an increased risk of electric shock if your body is earthed or grounded.*
- c) **Do not expose power tools to rain or wet conditions.** *Water entering a power tool will increase the risk of electric shock.*
- d) **Do not abuse the cord. Never use the cord for carrying, pulling or unplugging the power tool. Keep cord away from heat, oil, sharp edges or moving parts.** *Damaged or entangled cords increase the risk of electric shock.*
- e) **When operating a power tool outdoors, use an extension cord suitable for outdoor use.** *Use of a cord suitable for outdoor use reduces the risk of electric shock.*
- f) **If operating a power tool in a damp location is unavoidable, use a residual current device (RCD) protected supply.** *Use of an RCD reduces the risk of electric shock.*

3) Personal safety

- a) **Stay alert, watch what you are doing and use common sense when operating a power tool. Do not use a power tool while you are tired or under the influence of drugs, alcohol or medication.** *A moment of inattention while operating power tools may result in serious personal injury.*
- b) **Use personal protective equipment. Always wear eye protection.** *Protective equipment such as a dust mask, non-skid safety shoes, hard hat or hearing protection used for appropriate conditions will reduce personal injuries.*
- c) **Prevent unintentional starting. Ensure the switch is in the off-position before connecting to power source and/or battery pack, picking up or carrying the tool.** *Carrying power tools with your finger on the switch or energising power tools that have the switch on invites accidents.*
- d) **Remove any adjusting key or wrench before turning the power tool on.** *A wrench or a key*

left attached to a rotating part of the power tool may result in personal injury.

- e) **Do not overreach. Keep proper footing and balance at all times.** *This enables better control of the power tool in unexpected situations.*
- f) **Dress properly. Do not wear loose clothing or jewellery. Keep your hair and clothing away from moving parts.** *Loose clothes, jewellery or long hair can be caught in moving parts.*
- g) **If devices are provided for the connection of dust extraction and collection facilities, ensure these are connected and properly used.** *Use of dust collection can reduce dust-related hazards.*
- h) **Do not let familiarity gained from frequent use of tools allow you to become complacent and ignore tool safety principles.** *A careless action can cause severe injury within a fraction of a second.*

4) Power tool use and care

- a) **Do not force the power tool. Use the correct power tool for your application.** *The correct power tool will do the job better and safer at the rate for which it was designed.*
- b) **Do not use the power tool if the switch does not turn it on and off.** *Any power tool that cannot be controlled with the switch is dangerous and must be repaired.*
- c) **Disconnect the plug from the power source and/or remove the battery pack, if detachable, from the power tool before making any adjustments, changing accessories, or storing power tools.** *Such preventive safety measures reduce the risk of starting the power tool accidentally.*
- d) **Store idle power tools out of the reach of children and do not allow persons unfamiliar with the power tool or these instructions to operate the power tool.** *Power tools are dangerous in the hands of untrained users.*
- e) **Maintain power tools and accessories. Check for misalignment or binding of moving parts, breakage of parts and any other condition that may affect the power tool's operation.** *If damaged, have the power tool repaired before use. Many accidents are caused by poorly maintained power tools.*
- f) **Keep cutting tools sharp and clean.** *Properly maintained cutting tools with sharp cutting edges are less likely to bind and are easier to control.*
- g) **Use the power tool, accessories and tool bits etc. in accordance with these instructions, taking into account the working conditions and the work to be performed.** *Use of the power tool for operations different from those intended could result in a hazardous situation.*
- h) **Keep handles and grasping surfaces dry, clean and free from oil and grease.** *Slippery handles and grasping surfaces do not allow for safe handling and control of the tool in unexpected situations.*

5) Battery tool use and care

- a) **Recharge only with the charger specified by the manufacturer.** *A charger that is suitable for one type of battery pack may create a risk of fire when used with another battery pack.*
- b) **Use power tools only with specifically designated battery packs.** *Use of any other battery packs may create a risk of injury and fire.*
- c) **When battery pack is not in use, keep it away from other metal objects, like paper clips, coins, keys, nails, screws or other small metal objects, that can make a connection from one terminal to another.** *Shorting the battery terminals together may cause burns or a fire.*
- d) **Under abusive conditions, liquid may be ejected from the battery; avoid contact. If contact accidentally occurs, flush with water. If liquid contacts eyes, additionally seek medical help.** *Liquid ejected from the battery may cause irritation or burns.*
- e) **Do not use a battery pack or tool that is damaged or modified.** *Damaged or modified*

batteries may exhibit unpredictable behaviour resulting in fire, explosion or risk of injury.

f) Do not expose a battery pack or tool to fire or excessive temperature. Exposure to fire or temperature above 130 °C may cause explosion.

g) Follow all charging instructions and do not charge the battery pack or tool outside the temperature range specified in the instructions. Charging improperly or at temperatures outside the specified range may damage the battery and increase the risk of fire.

6) Service

a) Have your power tool serviced by a qualified repair person using only identical replacement parts. This will ensure that the safety of the power tool is maintained.

b) Never service damaged battery packs. Service of battery packs should only be performed by the manufacturer or authorized service providers.

1.2 SAFETY INSTRUCTIONS FOR CHAIN SAWS

1) General chain saw safety warnings:

a) Keep all parts of the body away from the saw chain when the chain saw is operating. Before you start the chain saw, make sure the saw chain is not contacting anything. A moment of inattention while operating chain saws may cause entanglement of your clothing or body with the saw chain.

b) Always hold the chain saw with your right hand on the rear handle and your left hand on the front handle. Holding the chain saw with a reversed hand configuration increases the risk of personal injury and should never be done.

c) Hold the chain saw by insulated gripping surfaces only, because the saw chain may contact hidden wiring. Saw chains contacting a "live" wire may make exposed metal parts of the chain saw "live" and could give the operator an electric shock.

d) Wear eye protection. Further protective equipment for hearing, head, hands, legs and feet is recommended. Adequate protective equipment will reduce personal injury from flying debris or accidental contact with the saw chain.

e) Do not operate a chain saw in a tree, on a ladder, from a rooftop, or any unstable support. Operation of a chain saw in this manner could result in serious personal injury.

f) Always keep proper footing and operate the chain saw only when standing on fixed, secure and level surface. Slippery or unstable surfaces may cause a loss of balance or control of the chain saw.

g) When cutting a limb that is under tension, be alert for spring back. When the tension in the wood fibres is released, the spring loaded limb may strike the operator and/or throw the chain saw out of control.

h) Use extreme caution when cutting brush and saplings. The slender material may catch the saw chain and be whipped toward you or pull you off balance.

i) Carry the chain saw by the front handle with the chain saw switched off and away from your body. When transporting or storing the chain saw, always fit the guide bar cover. Proper handling of the chain saw will reduce the likelihood of accidental contact with the moving saw chain.

j) Follow instructions for lubricating, chain tensioning and changing the bar and chain. Improperly tensioned or lubricated chain may either break or increase the chance for kickback.

k) Cut wood only. Do not use chain saw for purposes not intended. For example: do not use chain saw for cutting metal, plastic, masonry or non-wood building materials. Use of the chain saw for operations different than intended could result in a hazardous situation.

l) Do not attempt to fell a tree until you have an understanding of the risks and how to avoid them.

Serious injury could occur to the operator or bystanders while felling a tree.

m) This chain saw is not intended for tree felling. *Use of the chain saw for operations different than intended could result in serious injury to the operator or bystanders.*

2) Causes and operator prevention of kickback

- Kickback may occur when the nose or tip of the guide bar touches an object, or when the wood closes in and pinches the saw chain in the cut.
- Tip contact in some cases may cause a sudden reverse reaction, kicking the guide bar up and back towards the operator.
- Pinching the saw chain along the top of the guide bar may push the guide bar rapidly back towards the operator.
- Either of these reactions may cause you to lose control of the saw which could result in serious personal injury. Do not rely exclusively upon the safety devices built into your saw.
- As a chain saw user, you should take several steps to keep your cutting jobs free from accident or injury.
- Kickback is the result of chain saw misuse and/or incorrect operating procedures or conditions and can be avoided by taking proper precautions as given below:
 - a) Maintain a firm grip, with thumbs and fingers encircling the chain saw handles, with both hands on the saw and position your body and arm to allow you to resist kickback forces.** *Kickback forces can be controlled by the operator, if proper precautions are taken. Do not let go of the chain saw.*
 - b) Do not overreach and do not cut above shoulder height.** *This helps prevent unintended tip contact and enables better control of the chain saw in unexpected situations.*
 - c) Only use replacement guide bars and saw chains specified by the manufacturer.** *Incorrect replacement guide bars and saw chains may cause chain breakage and/or kickback.*
 - d) Follow the manufacturer's sharpening and maintenance instructions for the saw chain.** *Decreasing the depth gauge height can lead to increased kickback.*

3) General chain saw safety warnings

- a) Follow all instructions when clearing jammed material, storing or servicing the chain saw.** *Make sure the switch is off and the battery pack is removed. Unexpected actuation of the chain saw while clearing jammed material or servicing may result in serious personal injury.*

1.3 ADDITIONAL INSTRUCTIONS

- First-time user should, as a minimum, practice cutting logs on a saw-horse or cradle.
- Wear protective gloves, protective helmet, ocular protection, hearing protection and a protective mask.
- This chain saw is not suitable for tree felling.
- Do not operate the chain saw without lubrication. Use a lubricant for lubricating the blade. Use only recommended lubricants (ask advice to your dealer or our service agent).

1.4 SPECIAL SAFETY INSTRUCTIONS FOR BATTERY-OPERATED TOOLS

- 1) Ensure that the tool is switched off before inserting the battery. Inserting a battery into a tool that is switched on may result in accidents.

- 2) Recharge the batteries indoors only because the battery charger is designed for indoor use only.
Risk of electric shock.
- 3) To reduce the electric shock hazard, unplug the battery charger from the mains before cleaning the charger.
- 4) Do not subject the battery to strong sunlight over long periods and do not leave it on a heater.
Heat damages the battery and this is risk of explosion.
- 5) Allow a hot battery to cool before charging.
- 6) Do not open up the battery and avoid mechanical damage to the battery. Risk of short circuit and fumes may be emitted that irritate the respiratory tract. Ensure fresh air and seek medical assistance in the event of discomfort.
- 7) Do not use non-rechargeable battery. This could damage the appliance.
- 8) The recommended ambient temperature range for the charging system during charging is from 4°C to 40°C.
- 9) The recommended ambient temperature range for tool and battery storage is from 0°C to 50°C.
- 10) The recommended ambient temperature range for tool and battery use is from -5°C to 50°C.
- 11) Remove the battery from the device before storage.
- 12) Electrolyte leaking from the cells can cause damage to the skin, clothes or any other items exposed to it. If the electrolyte contacts the skin or clothes, wash thoroughly with clean water. If the electrolyte enters into the eyes, do not rub the eyes but flush them immediately with copious amounts of clean water such as tap water, and immediately consult a doctor.
- 13) Do not disassemble or modify the battery, which can cause short-circuiting between cells or between the cell and its wiring, and disables the battery's safety protection system. These can lead to electrolyte leakage, overheating or a cell or battery, bursting and fire.
- 14) Avoid casual or inadvertent shorting of a battery with metallic objects such as: wire, tools, neckless or hairpins, which can cause short-circuiting, which cause excess current flow, electrolyte leakage, heating of cells or batteries, bursting and fire.
- 15) Keep battery away from a fire or heat. The insulation materials will melt and the gas release vent and protection system will be damaged, causing electrolyte leakage, bursting and possibly fire.
- 16) Not allow the battery to contact with water or gets wet, it may short-circuit, overheat, rust or lose its functions.
- 17) Do not expose the battery to mechanical shock, for example, by dropping, throwing or crushing, causing electrolyte leakage, cell and battery heating, bursting and fire.
- 18) Avoid the battery to directly connect to electric source such as a car lighter socket, or car battery, which may cause excess current to flow at high voltage and can cause electrolyte leakage, overheating of a cell or battery, bursting and fire.

1.6 VIBRATION AND NOISE REDUCTION

To reduce the impact of noise and vibration emission, limit the time of operation, use low-vibration and low noise operating modes as well as wear personal protective equipment.

Take the following points into account to minimize the vibration and noise exposure risks:

- 1) Only use the product as intended by its design and these instructions.
- 2) Ensure that the product is in good condition and well maintained.
- 3) Use correct attachments for the product and ensure they are in good condition.
- 4) Keep tight grip on the handles surface.
- 5) Plan your work schedule to spread any high vibration tool use across a longer period of time.

1.7 RESIDUAL RISK







Even if properly operating and handling this product in accordance with all the safety requirements, potential risks of injury and damage remain. Due to its construction and build, this tool may present the following hazards:

- 1) Electric shock from insufficient insulation. Do not use the product when the product or your hands are damp or wet.
- 2) Ear damage if working without ear protection.
- 3) There is a risk of a short-circuit due to liquid penetrating the housing. Do not immerse the product and the accessories in water. And make sure that no water or other liquid can enter the housing.
- 4) Damage to your health caused by swinging your hands and arms when operating the tool for longer periods of time or if the tool is not held or maintained properly.

WARNING!

During operating, the product generates an electromagnetic field which, under certain circumstances, may impair the functionality of active or passive medical implants. To reduce the risk of serious or lethal injuries, we recommend that persons with medical implants consult their doctor and the manufacturer of their medical implant before operating the electric tool.

1.8 SYMBOLS

	<p>Conforms to relevant safety standards.</p>
	<p>To reduce the risk of injury, the user must read and understand this manual before using this product.</p>
	<p>Wear eye protection, protective hat and hearing protection</p>
	<p>Beware of chain saw kickback and avoid contact with bar tip.</p>
	<p>Do not expose to rain.</p>
	<p>Do not dispose of old appliances with domestic rubbish.</p>

2. KNOW YOUR PRODUCT

2.1 DESCRIPTION



2.2 TECHNICAL DATA

Rated voltage	20V d.c.
Cutting capacity	127mm
Chain speed	4.8m/s
Guide bar	Length 151 mm
Chain saw type	Pitch 6,35
Battery type(not included)	EZB2A, 20V d.c. 2,0Ah, Lithium-ion EZB4A, 20V d.c. 4,0Ah, Lithium-ion
Charger type(not included)	EZCR20V-1, Input 220-240V~ 50-60Hz, 65W Output 21V d.c., 2,5A
Sound pressure level	Max. LpA =82,7 dB(A), K= 3 dB(A)
Sound power level	Max. LwA =92,4dB(A), K= 3 dB(A)
Sound power guarantee	95dB(A)
Vibrations Ah,AG	Max. ah,AG=3,4 m/s ² , K=1,5 m/s ²

INFORMATION

- The declared vibration total value(s) and the declared noise emission value(s) have been measured in accordance with a standard test method and may be used for comparing one tool with another;
- that the declared vibration total value(s) and the declared noise emission value(s) may also be used in a preliminary assessment of exposure.

WARNING!

- that the vibration and noise emissions during actual use of the power tool can differ from the declared values depending on the ways in which the tool is used especially what kind of workpiece is processed; and
 - of the need to identify safety measures to protect the operator that are based on an estimation of exposure in the actual conditions of use (taking account of all parts of the operating cycle such as the times when the tool is switched off and when it is running idle in addition to the trigger time).
- Wear hearing protection.

3. ASSEMBLY

3.1 ASSEMBLY/ REPLACE OF GUIDE BAR AND SAW CHAIN



Counterclockwise spin the bar tightening knob, and remove the side panel cover.

Install the guide place and chain, pay attention to the direction of the chain.

Attached the side panel cover.



Attached the side panel cover clockwise spin the tool-free chain tensioning to adjust the tightness of the chain.

Rotate the bar tightening knob for proper bar clamping force.

Insert the battery pack into the slot of bottom, check if the safety lock is locked and then you can use it

3.2 HOW TO ADJUST THE TIGHTNESS THE CHAIN

The chain is loose

Adjust the tightness of the chain

Ready to use



3.3 CHAIN OIL CAN LUBRICATE AND COOL THE CHAIN

- 1) Turn off the chain saw and remove the battery pack.
- 2) Place the chain saw flat on a flat surface with the sprocket cover facing up.
- 3) Use a soft brush or resin solvent to clean the guide plate and saw chain.
- 4) Apply multifunctional lubricant to the area (1) between the guide plate and the saw chain.

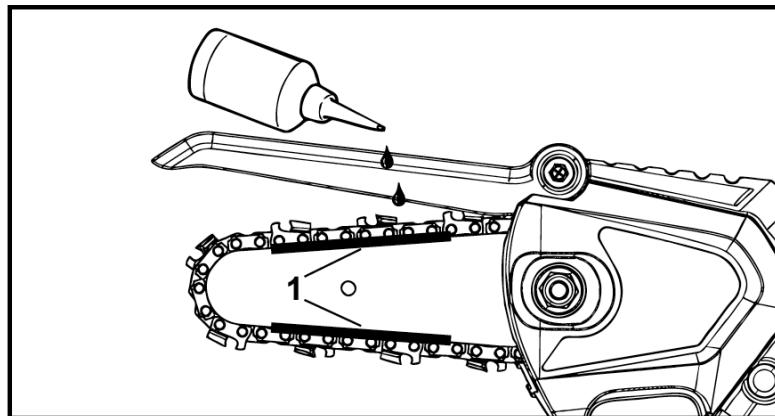

4. OPERATION

4.1 INSTALLING/REMOVAL THE BATTERY

Note: battery and charger not included in the pack, you can buy Energizer 20V battery platform 2Ah or 4Ah.

- 1) Slide the battery under the power input interface until hearing a click.
- 2) To remove the battery, push the unlock button located on the top of the battery. Then slide the battery to remove it.

4.2 STARTING AND STOPPING

- 1) To start the tool push and hold the self-locking switch. Then press the power switch to start the operation.
- 2) To stop the operation, release the trigger and then the self-locking switch.

4.3 PRECAUTIONS FOR CUTTING

- 1) In some specific cases, the operator may not focus on the work, the operator may trip, fall and cause serious injury.
 - a. Keep calm and work in a planned way
 - b. Do not use chain saw in dim and low visibility environment
 - c. Please operate your own chain saw
 - d. Do not operate the chain saw higher than your shoulder
 - e. Watch out for obstacles
 - f. When operating the chain saw, please stand in a safe position and keep balance. If you need to work at height, use a lift or a safe scaffold
- 2) The running saw chain may hurt the user. Please do not touch the moving saw chain. Otherwise, the user may be seriously injured.
- 3) If the saw chain cannot effectively cool down and re tension, the saw chain may jump out of the guide plate and lead to breakage. These can lead to serious injury and property damage.
 - a. Ensure that the saw chain is lubricated properly
 - b. Please check whether the tension of the saw chain is proper during operation. If the saw chain is loose, adjust it in time
- 4) If the chain saw starts abnormally or runs abnormally in the work, the chain may be in an unsafe state, which may lead to serious personal injury or property loss. Stop working immediately and contact the dealer.
- 5) The chain saw will vibrate when it is running.
 - a. Please wear gloves
 - b. Stop and rest in time
 - c. Consult your doctor if you are in poor health
- 6) If the running saw chain touches a hard object, it will produce sparks. Sparks can cause fire in combustible environment, which can cause serious injury and property loss. Do not use chain saw in combustible environment.
- 7) When the trigger is released, the chain saw will run for a period of time. It is necessary to wait for the chain saw to stop completely, otherwise it may cause serious injury.

If the chain saw is used with the tree tensioned, the guide plate may get stuck. Users will lose control of the chain saw, resulting in serious injury. (Figure 1)

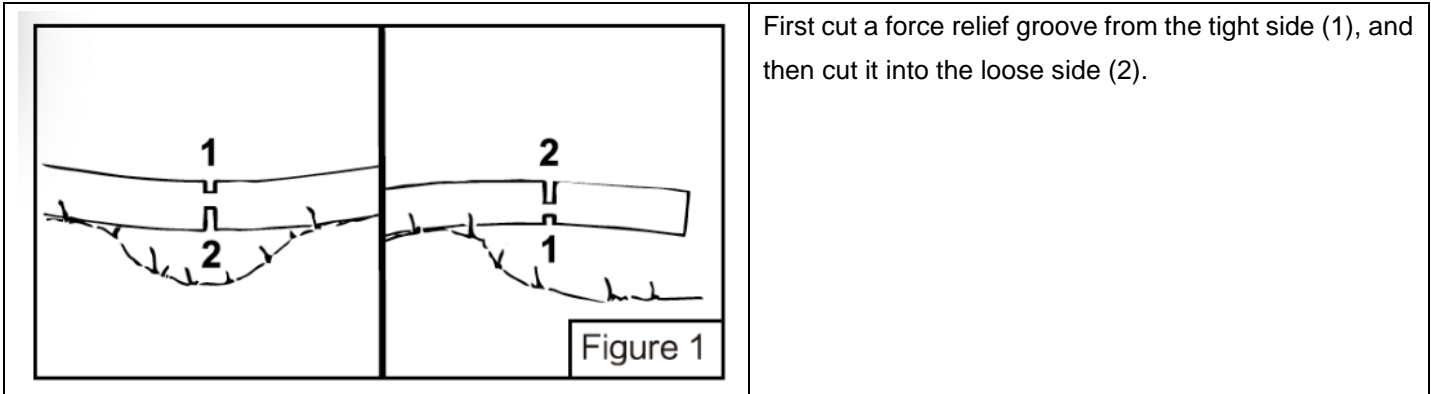

4.4 PRECAUTIONS FOR PRUNING

If the branches under the fallen tree are pruned first, the trunk will not be supported by the branches. Trees

can roll, causing serious or fatal injuries.

- Turn the main pole over and trim the branches on it
- Do not stand on the log for pruning

4.5 PRECAUTIONS FOR LOGGING

- 1) Inexperienced personnel are not allowed to approach dangerous logging sites, otherwise serious or fatal personal injury and property damage may result. Please don't cut wood alone.
- 2) Branches or other objects from a fallen tree may fall on an onlooker. May cause serious or fatal personal injury and property damage.
 - a. Judge the direction of the tree so that it can fall smoothly.
 - b. Bystanders, children and animals are not allowed to stay within 2.5 Tree lengths
 - c. Observe the crown of the tree and the crown of the adjacent tree to ensure that there is no interference from the branches when the crown falls.
- 3) When the tree falls, the trunk may break or spring towards the operator. May cause serious or fatal personal injury.
 - a. Plan your escape route around you.
 - b. Observe the direction of the fallen tree and escape to the planned escape route.
 - c. Don't go uphill.
- 4) Obstacles in the workplace or escape route will hinder the escape. People fleeing may fall, causing serious or fatal injury.
 - a. Clear the work area and escape route.
- 5) If there is a fixed hinge or stable rope on the trunk, the tree may fall uncontrollably and prematurely, which will cause serious or fatal injury and property loss to the operator.
 - a. Do not use hinges
 - b. Finally, use the stabilizing rope.
 - c. If the tree falls ahead of time, please give up logging and follow the escape route.
- 6) When cutting, if the head of the guide plate touches an object or the wood clamps and extrudes the chain, it may cause rebound. Sometimes, when the head of the guide plate touches an object, it will form a sudden reaction force, which will spring up the guide plate and rush to the operator, causing injury to the operator.
- 7) If the direction of the tree falling is uncontrollable or falls on top of other trees, and the operator cannot complete the logging operation in a controllable way, the logging operation should be stopped and a suitable vehicle should be selected to pull down the tree with a rope.

4.6 OPERATION OF TIMBER MAKING



WARNING!

If the chain saw rebounds, the chain saw will spring to the operator. Can cause serious or fatal injury.

- 1) When cutting, it is necessary to cut at full speed.
- 2) Do not cut with the guide head.
- 3) When cutting, keep the chain saw at full speed and the guide plate vertical.
- 4) According to the width of the guide plate, the head of the guide plate shall expose the cut trees.
- 5) Add the weight of the chain saw to the guide plate.

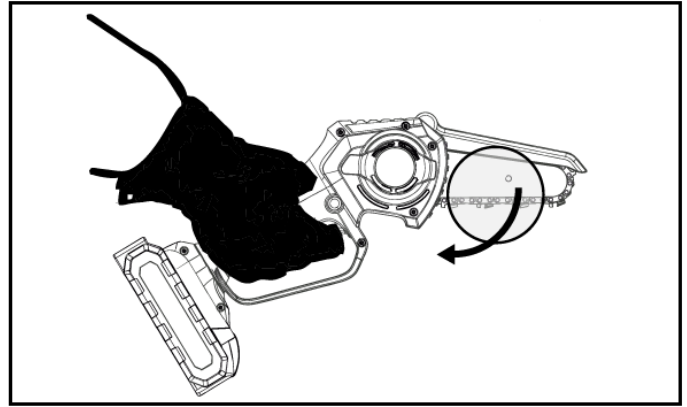
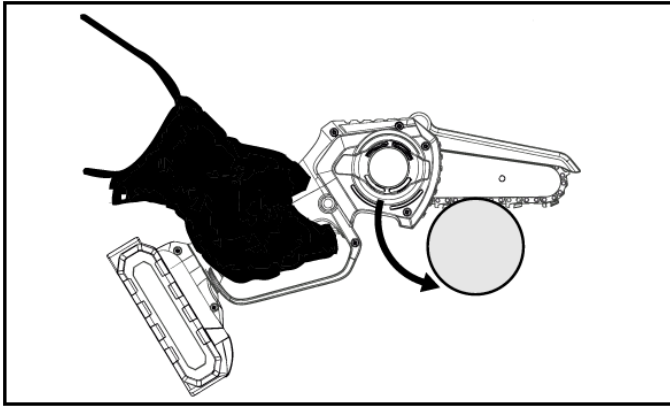

4.7 PRUNING OF BRANCHES

- 1) Put the chain saw guide on the branch to be pruned.
- 2) Chain cutting at full speed.
- 3) Cut the branch with the upper part of the guide plate.
- 4) Cut the branch with tension: first cut a small opening (1) on the loose side, and cut continuously under the tension.

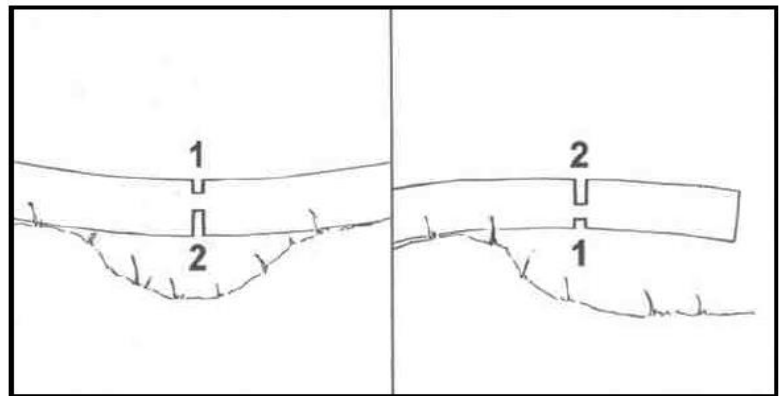
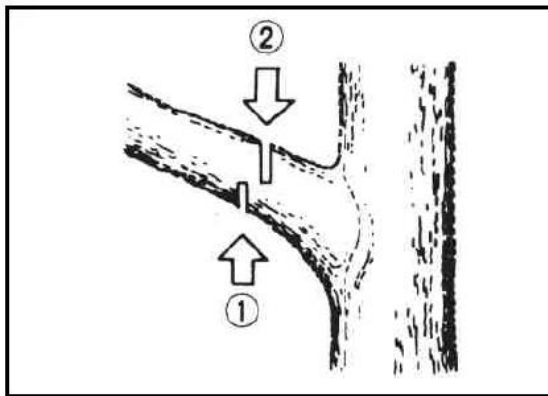

5. CLEANING AND MAINTENANCE

- 1) In the state of cleaning, maintenance or repair, if the battery pack is not disconnected from the tool, the chain saw may start suddenly, resulting in serious personal injury and property loss.
 - a. Cut off the power.
 - b. Remove the working head of the chain saw.
 - c. Remove guide plate and chain.
- 2) Corrosive cleaning agents, high-pressure cleaning equipment or sharp cleaning tools may damage chain saws, guides, chains, battery packs and chargers. If the chain saw, guide plate, chain, battery pack and charger cannot be cleaned in the correct way, the relevant parts may no longer function as they should, or the safety device may no longer function, which can cause serious injury.
 - a. Clean the chain saw, guide plate, chain, battery pack and charger according to the instructions.
- 3) If the chain saw, guide plate, chain, battery pack and charger cannot be cleaned and maintained in the correct way, the relevant parts may no longer function as they should, or the safety device may no longer function, which will lead to serious injury.
 - a. Don't try to repair chain saws, battery packs, chargers
 - b. If the chain saw, battery pack and charger need maintenance, please contact the dealer in time.
 - c. Maintain the guide plate and chain as described in the manual.

- 4) When cleaning and maintaining the chain saw, the user may be injured by the sharp blade, which may cause personal injury.
 - a. Please wear scratch resistant gloves
- 5) The sharpening and all others maintenance shall be performed by authorized service center.

5.1 CLEANING OF CHAIN SAW

- 1) Turn off the chain saw. Cut off the power.
- 2) Wipe the body of the chain saw with a wet cloth.
- 3) Remove the sprocket guard.
- 4) Clean the rim of the sprocket and the body with a wet cloth.
- 5) Use a soft brush when cleaning the battery pack charger.
- 6) Install the sprocket cover.

5.2 CLEAN THE GUIDES AND CHAINS

- 1) Turn off the chain saw. Cut off the power.
- 2) Remove the guide plate and chain.
- 3) Use a soft brush to clean the rear slot of the guide plate.
- 4) Use a soft brush to clean the chain.
- 5) Install the guide and chain.

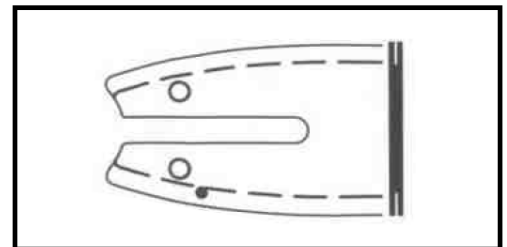

5.3. MAINTENANCE OF CHAIN WHEEL

- 1) The user is not allowed to remove the sprocket by himself.
- 2) If the sprocket is damaged or defective: please do not use the device, contact the dealer in time to replace it.
- 3) Maintenance guide plate: if there is burr on the edge of guide plate groove, please polish it in time.

5.4 GRINDING CHAIN

CAUTION: sharpening of the saw chain performed by authorized service center.
The chain should be polished with special round file instead of ordinary round file.

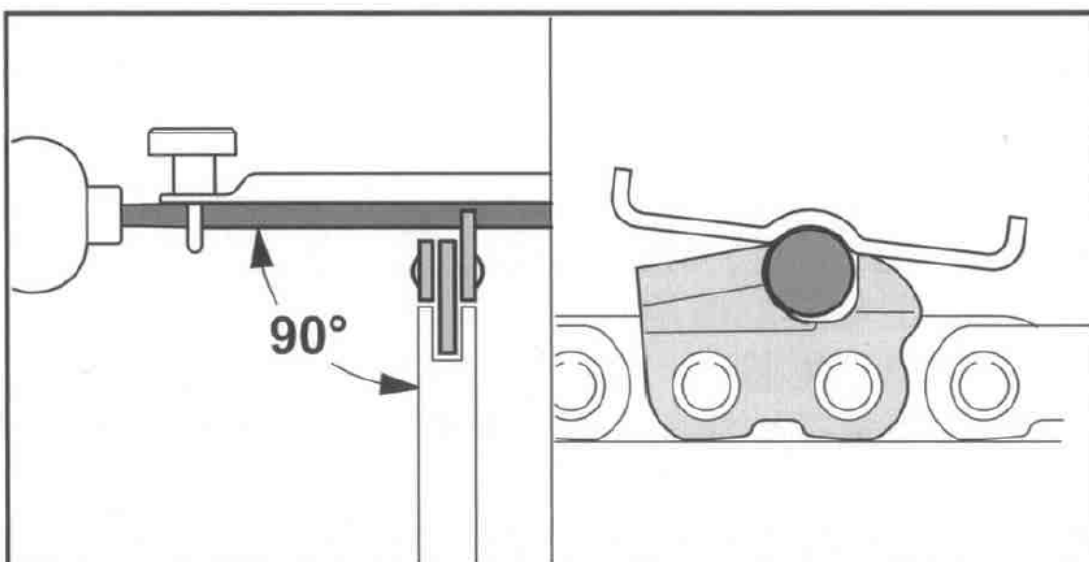

The file should only grind the saw blade forward in one direction, and do not make the file contact the saw blade when pulling back. First, grind the shortest saw blade, and the length of the saw blade is the reference dimension of other saw blades on the chain

- 1) The round file must match the pitch of the chain
- 2) Round file head from inside out
- 3) File in one direction according to the angle of the cutter head
- 4) Please keep the blade angle
- 5) Grind the small teeth of the file head according to the depth of the guide plate groove
- 6) If you have any questions, please contact the dealer.

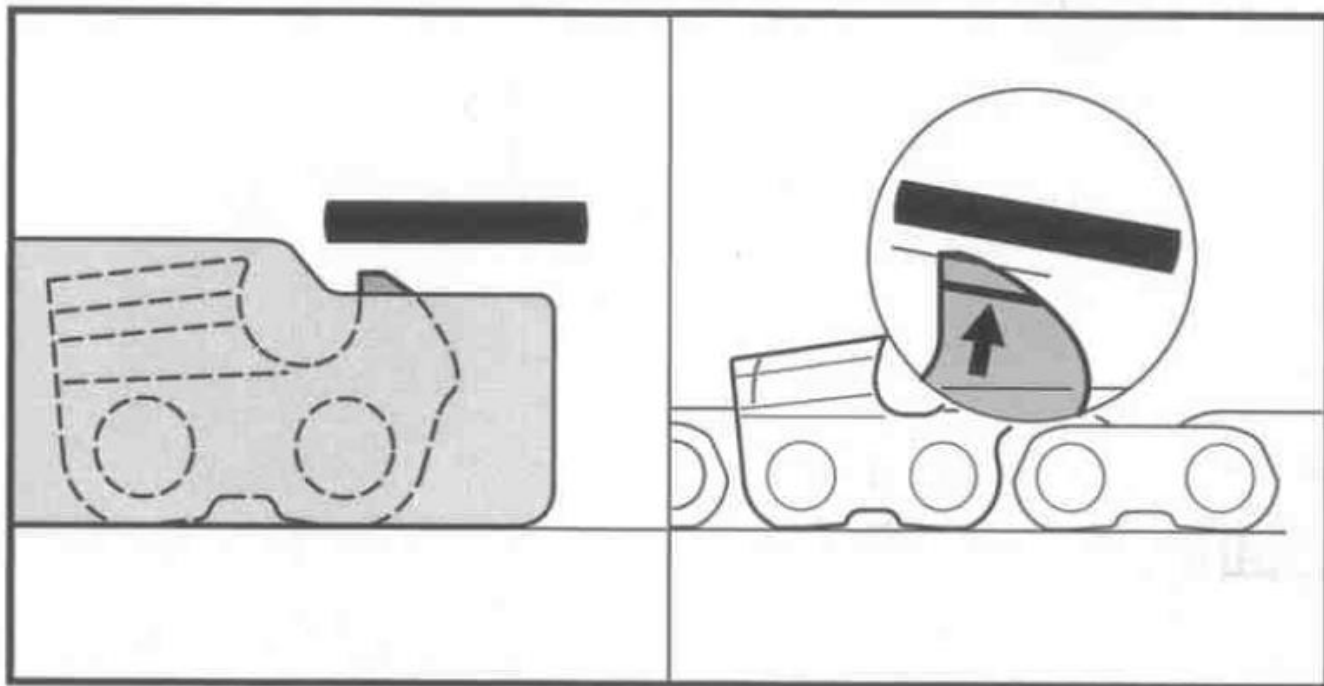

6. DISPOSAL

Electrical products should not be discarded with household products. According to the European



Directive 2012/19/EU on waste electrical and electronic equipment and its implementation into national law, electrical products used must be collected separately and disposed of at collection points provided for this purpose. Talk with your local authorities or dealer for advice on recycling.

7. DELARATION OF CONFORMITY



BUILDER SAS

32, rue Aristide Bergès - ZI 31270 Cugnaux - France,

Declares that,

Product: Cordless PRUNING MACHINE

Model: EZ20VSIJ-A

Serial number: 20221106040-20221106339

Is in conformity with the essential requirements and other relevant provisions of the applicable European Directives, based on the application of European harmonized standards. Any unauthorized modification of the apparatus voids this declaration.

European Directives (including, if applicable, their amendments up to the date of signature);

Rohs directive 2011/65/EU + (EU) 2015/863

2014/30/EU; 2006/42/EC

European harmonized standards

EN 62841-1:2015+A11:2022

EN ISO 12100:2010

EN IEC55014-1: 2021

EN IEC55014-2: 2021

Cugnaux, 21/10/2022

Philippe MARIE / PDG

Responsible of the technical file: Mr Olivier Patriarca

8. WARRANTY

Energizer[®]

WARRANTY

The manufacturer guarantees the product against defects in material and workmanship for a period of 2 years from the date of the original purchase. The warranty only applies if the product is for household use. The warranty does not cover breakdowns due to normal wear and tear.

The manufacturer agrees to replace parts identified as defective by the designated distributor. The manufacturer does not accept responsibility for the replacement of the machine, in whole or in part, and/or ensuing damage.

The warranty does not cover breakdowns due to:

- insufficient maintenance.
- abnormal assembly, adjustment or operations of the product.
- parts subject to normal wear and tear.

The warranty does not extend to:

- shipping and packaging costs.
- using the tool for a purpose other than that for which it was designed.
- the use and maintenance of the machine done in a manner not described in the user manual.

Due to our policy of continuous product improvement, we reserve the right to alter or change specifications without notice. Consequently, the product may be different from the information contained therein, but a modification will be undertaken without notice if it is recognized as an improvement of the preceding characteristic.

READ THE MANUAL CAREFULLY BEFORE USING THE MACHINE.

When ordering spare parts, please indicate the part number or code, you can find this in the spare parts list in this manual. Keep the purchase receipt; without it, the warranty is invalid. To help you with your product, we invite you to contact us by phone or via our website:

- **+33 (0)9.70.75.30.30**
- **<https://services.swap-europe.com/contact>**

You must create a "ticket" via the web platform.

- Register or create your account.
- Indicate the reference of the tool.
- Choose the subject of your request.
- Describe your problem.
- Attach these files: invoice or sales receipt, photo of the identification plate (serial number), photo of the part you need (for example: pins on the transformer plug which are broken).



9. PRODUCT FAILURE

WHAT TO DO IF MY MACHINE BREAKS DOWN?

If you bought your product in a store:

- a) Empty the fuel tank if your product has one.
- b) Make sure that your machine is complete with all accessories supplied, and clean! If this is not the case, the repairer will refuse the machine.

Go to the store with the complete machine and with the receipt or invoice.

If you bought your product on a website:

- a) Empty the fuel tank if your product has one.
- b) Make sure that your machine is complete with all accessories supplied, and clean! If this is not the case, the repairer will refuse the machine.
- c) Create a SWAP-Europe service ticket on the site: <https://services.swap-europe.com>. When making the request on SWAP-Europe, you must attach the invoice and the photo of the nameplate (serial number).
- d) Contact the repair station to make sure it is available before dropping off the machine.

Go to the repair station with the complete machine packed, accompanied by the purchase invoice and the station support sheet downloadable after the service request is completed on the SWAP-Europe site.

For machines with engine failure from manufacturers BRIGGS & STRATTON, HONDA and RATO, please refer to the following instructions.

Repairs will be done by approved engine manufacturers of these manufacturers, see their site:

- <http://www.briggsandstratton.com/eu/fr>
- <http://www.honda-engines-eu.com/fr/service-network-page;jsessionid=5EE8456CF39CD572AA2AEEDFD290CDAE>
- <https://www.rato-europe.com/it/service-network>

Please keep your original packaging to allow for after-sales service returns or pack your machine with a similar cardboard box of the same dimensions.

For any question concerning our after-sales service you can make a request on our website <https://services.swap-europe.com>

Our hotline remains available at +33 (9) 70 75 30 30.



10. WARRANTY EXCLUSIONS

THE WARRANTY DOES NOT COVER:

- Start-up and setting up of the product.
- Damage resulting from normal wear and tear of the product.
- Damage resulting from improper use of the product.
- Damage resulting from assembly or start-up not in accordance with the user manual.
- Breakdowns related to carburetion beyond 90 days and fouling of carburetors.
- Periodic and standard maintenance events.
- Actions of modification and dismantling that directly void the warranty.
- Products whose original authentication marking (brand, serial number) has been degraded, altered or withdrawn.
- Replacement of consumables.
- The use of non-original parts.
- Breakage of parts following impacts or projections.
- Accessories breakdowns.
- Defects and their consequences linked to any external cause.
- Loss of components and loss due to insufficient screwing.
- Cutting components and any damage related to the loosening of parts.
- Overload or overheating.
- Poor power supply quality: faulty voltage, voltage error, etc.
- Damages resulting from the deprivation of enjoyment of the product during the time necessary for repairs and more generally the costs related to the immobilization of the product.
- The costs of a second opinion established by a third party following an estimate by a SWAP-Europe repair station.
- The use of a product which would show a defect or a breakage which was not the subject of an immediate report and/or repair with the services of SWAP-Europe.
- Deterioration linked to transport and storage*.
- Launchers beyond 90 days.
- Oil, petrol, grease.
- Damages related to the use of non-compliant fuels or lubricants.

* In accordance with transport legislation, damage related to transport must be declared to carriers within 48 hours maximum after observation by registered letter with acknowledgement of receipt.

This document is a supplement to your notice, a non-exhaustive list.

Attention: All orders must be checked in the presence of the delivery person. In case of refusal by the delivery person, you must simply refuse the delivery and notify your refusal.

Reminder: The reserves do not exclude the notification by registered letter with acknowledgement within 72 hours.

Information: Thermal devices must be wintered each season (service available on the SWAP-Europe site). Batteries must be charged before being stored.

Energizer®